

NOMADICARK

INSTALLATION INSTRUCTIONS

RAD Window with Alu Blind

COMPONENTS

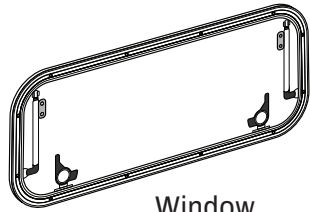

Window

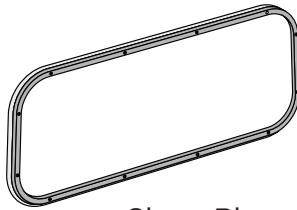

Clamp Ring

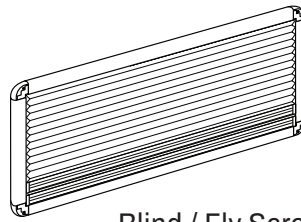

Blind / Fly Screen



x1 per hole

Clamp locator screws



x4

Blind screws



x4

Corner Caps

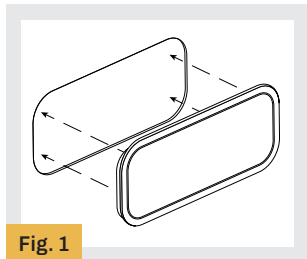

Fig. 1

STEP 1

Check the window size against the installation hole. Standard clearance requirement is 1.5mm between the window and installation hole.

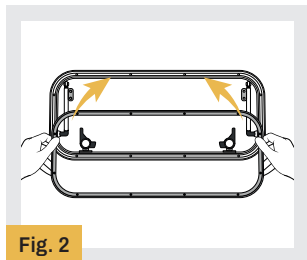

Fig. 2

STEP 2

With the window supported from the exterior, install the clamp ring from the vehicle interior by matching the locator screws.

The wall depth range is 25-35mm. If installing onto a narrower depth, a frame must be added before fitting the clamp ring.

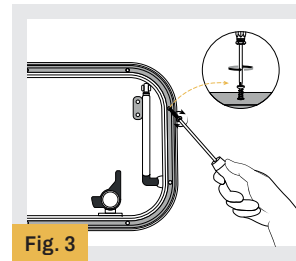

Fig. 3

STEP 3

Loosely fit all locator screws, then tighten by hand using a phillips head screwdriver.

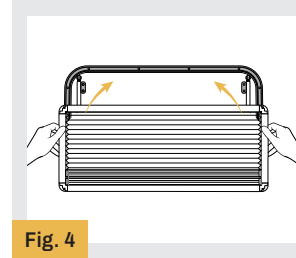

Fig. 4

STEP 4

The blinds are aligned with the installation hole, this should be done centrally, with even distance top-to-bottom and side-to-side. There is a groove between the inner edge of the blind and the window to assist with aligning.

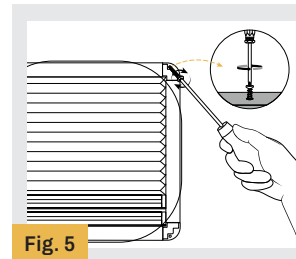

Fig. 5

STEP 5

Install the blind to the window using the cross groove countersunk head self-tapping screws provided. Do this via the four rounded corners.

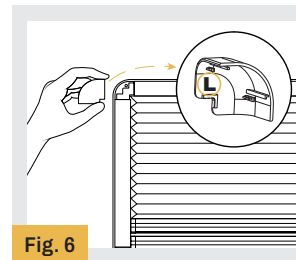

Fig. 6

STEP 6

Carefully add the round corner covers by fitting each into the slit with a matching L or R (on the inside). Remove all protective film from the covers.

NOTE. Improper installation, adjustment, alteration or maintenance can cause damage. Always refer to this manual. For assistance or additional information please consult a qualified installer, retailer or supplier.

NOMADICARK

RAD Window with Alu Blind

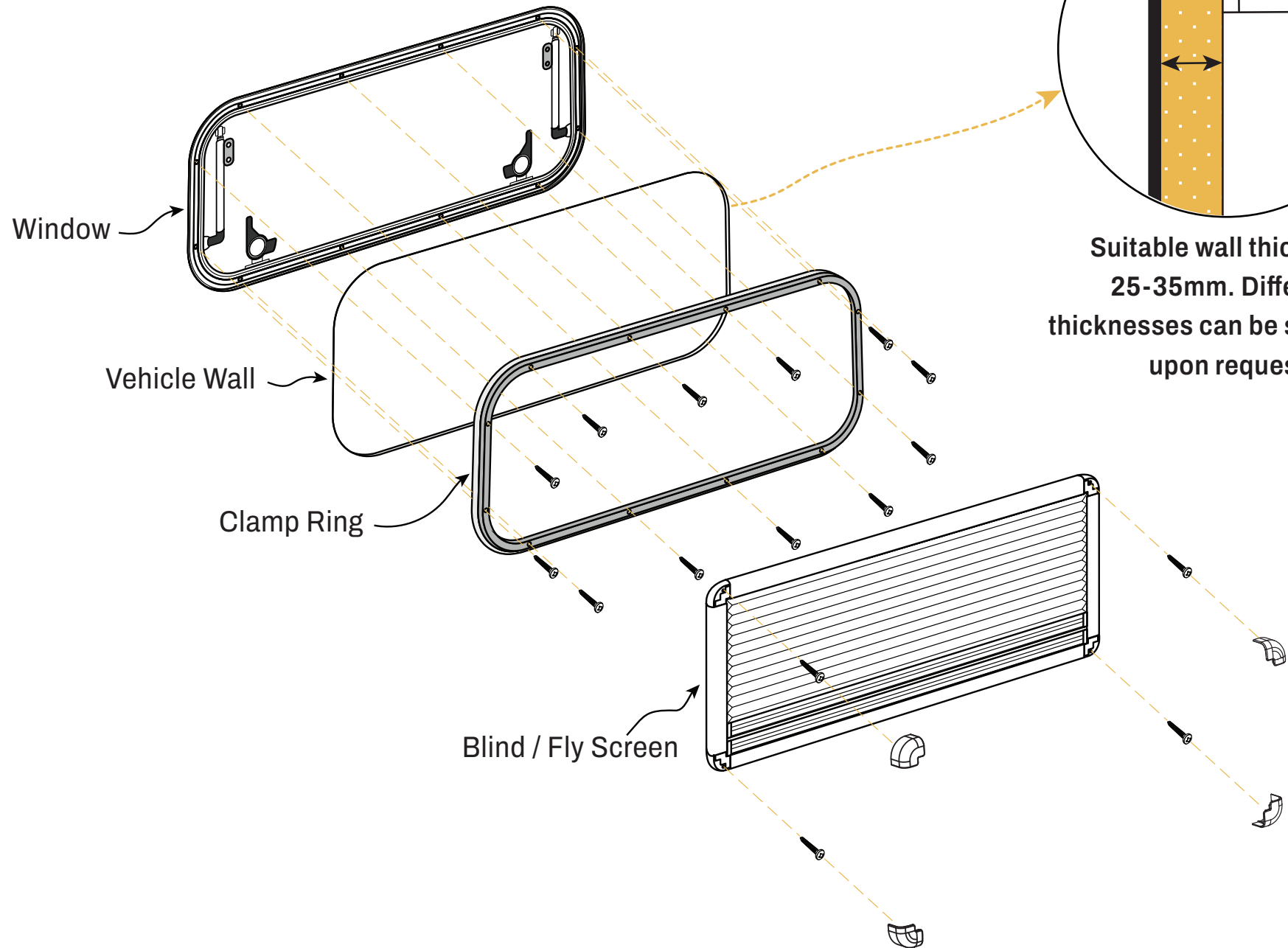

SIZING & CUT OUT

